

PITCH

USER MANUAL



The luminaire shall be installed by a qualified electrician and wired in accordance with the latest IEE electrical regulations or the national requirements.

Installation Instructions

A. Technical Parameters

Product name	PITCH
Product code	744
Input Voltage	DC 24V
Power	5 - 15W
Beam Angle	30°, 60°, 120°
Color temperature	SINGLE COLOR, R, G, B, RGB 3in1, RGBW 4in1
Colour rendering index	>70 CRI
Working Environment	-40°C to +50°C
Dimensions	500x22x61mm, 1000x22x61mm, 500x22x36mm, 1000x22x36mm
Net weight	0.5 - 1.0 Kg
Control Mode	On/Off, DMX-512

Installation Instructions

According to step 1, loosen the screw securing the brackets. Install the brackets in the desired position by moving them in the direction of the profile of the lamp, then fix the position of the brackets.

According to step 2, fix the lamp to the mounting surface with screws.

According to step 3, set the desired angle of rotation of the lamp.

According to step 4, fix the bracket with the desired angle.

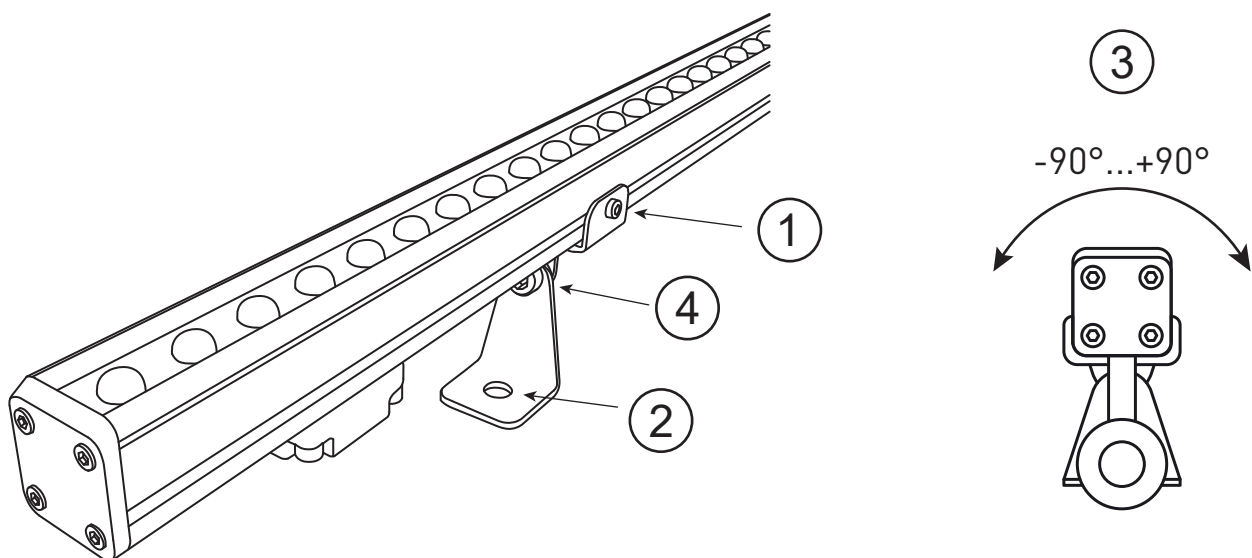

Overall dimensions

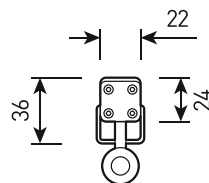
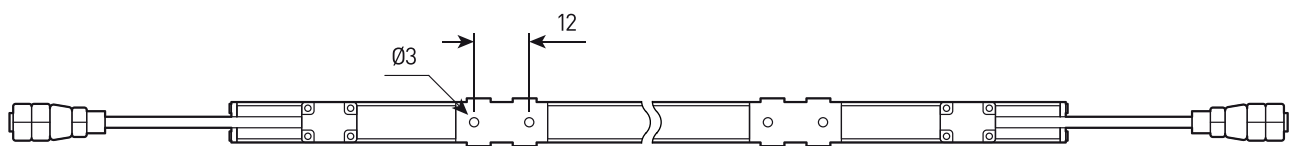
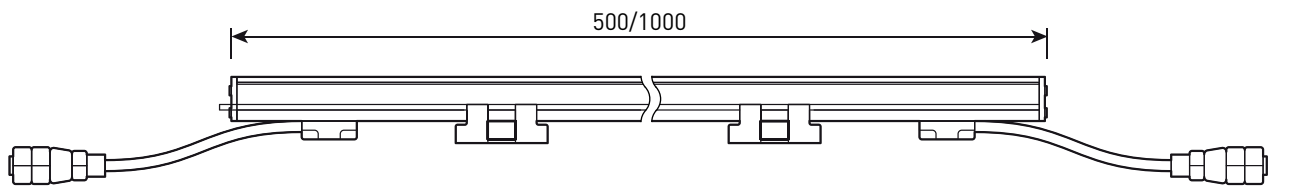
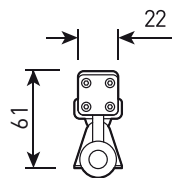
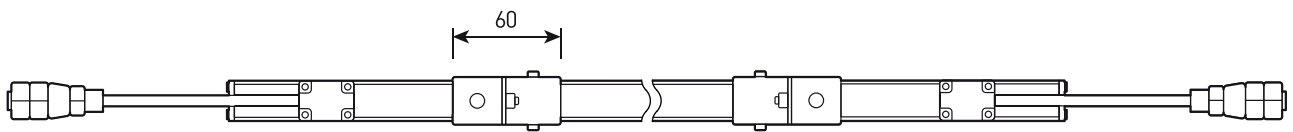
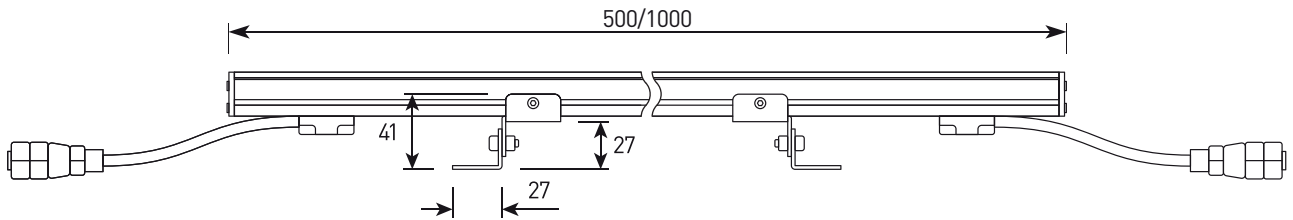

Connection diagram

24VDC SINGLE

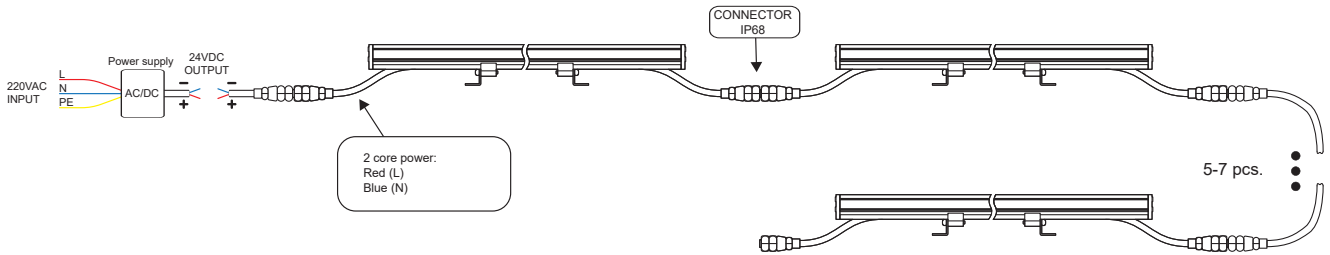

24VDC DMX

